

Mycobacterium leprae in Armadillo Tissues from Museum Collections, United States

Daniel Romero-Alvarez, Daniel Garzon-Chavez, Mary Jackson, Charlotte Avanzi, A. Townsend Peterson

We examined armadillos from museum collections in the United States using molecular assays to detect leprosy-causing bacilli. We found *Mycobacterium leprae* bacilli in samples from the United States, Bolivia, and Paraguay; prevalence was 14.8% in nine-banded armadillos. US isolates belonged to subtype 3I-2, suggesting long-term circulation of this genotype.

Hansen disease (leprosy) is an ancient pathology caused by 2 slow-growing intracellular bacilli, *Mycobacterium leprae* and *M. lepromatosis* (1). Both pathogens have the ability to damage peripheral nerves of hosts, producing a broad spectrum of clinical outcomes. Routes of disease transmission have been hypothesized for >100 years but are still actively debated (2); traditionally, human-to-human transmission has been considered the dominant route of infection. Evidence incriminates *M. leprae* as a zoonotic pathogen; the nine-banded armadillo (*Dasypus novemcinctus*) is its main wildlife reservoir in the southern United States (2). *M. leprae* also has been found in *D. novemcinctus* armadillos outside the United States (e.g., in Brazil), in the six-banded armadillo (*Euphractus sexcinctus*), and in nonhuman primates including chimpanzees, macaques, and sooty mangabeys (2). In addition, *M. leprae* and *M. lepromatosis* have been reported in red squirrels (*Sciurus vulgaris*) in the British Isles (3). Those data strongly suggest broad zoonotic transmission dynamics for both bacilli.

Natural history collections represent a neglected resource for biomedical research despite their known utility (4). We examined armadillo (family Dasypodidae) tissues deposited in museum collections across

the United States to identify *M. leprae* and *M. lepromatosis* across space and time. We report presence of *M. leprae* in armadillo tissue samples from endemic and nonendemic areas of the Americas, suggesting that public health policy should contemplate zoonotic leprosy transmission routes carefully.

The Study

We assembled a database of museum armadillo tissue samples using the biodiversity information portals VertNet (<http://portal.vertnet.org>) and Arctos (<https://arctos.database.museum/home.cfm>), queried during December 2018–April 2019. Ten US museums included armadillo samples in their datasets. The samples were collected during 1974–2017 (Appendix 1 Figure 4, <https://wwwnc.cdc.gov/EID/article/29/3/22-1636-App1.pdf>) from 8 countries across the Americas; 68.6% (n = 109) came from the United States (Table 1; Figure 1). Each museum contributed ≈1 mm³ of armadillo tissue (Appendix 1; Appendix 2, <https://wwwnc.cdc.gov/EID/article/29/3/22-1636-App2.xlsx>). The 159 samples processed corresponded to 10 armadillo species; *D. novemcinctus*, the nine-banded armadillo, was the most common (n = 122 [76.7%]). Most samples were liver tissues (n = 66 [41.5%]), followed by muscle (n = 37 [23.3%]) and spleen (n = 31 [19.5%]) (Table 1). The specimens were frozen or preserved in 10% dimethyl sulfoxide or 70%, 90%, or 95% ethanol; most were either frozen (n = 77 [48.4%]) or in 95% ethanol (n = 55 [34.6%]) (Table 1).

We processed tissues using an in-house DNA extraction method based on magnetic beads (Appendix 1). We applied standardized PCR protocols using specific primers to detect *M. leprae* and *M. lepromatosis* (5,6). For *M. leprae*, we implemented typification and subtyping as described previously (7). We performed quantitative real-time PCR (qPCR) on all samples for which genotyping was successful as a proxy of *M. leprae* DNA quantity with cycle threshold

Author affiliations: Universidad de las Américas, Quito, Ecuador (D. Romero-Alvarez); University of Kansas, Lawrence, Kansas, USA (D. Romero-Alvarez, A.T. Peterson); Universidad San Francisco de Quito, Quito, Ecuador (D. Garzon-Chavez); Colorado State University, Fort Collins, Colorado, USA (M. Jackson, C. Avanzi)

DOI: <https://doi.org/10.3201/eid2903.221636>

(Ct) <26 as a threshold for whole-genome sequencing. We multiplexed and sequenced libraries on an Illumina NextSeq 500 instrument (<https://www.illumina.com>) (Appendix 1).

We found *M. leprae* in 18/159 (11.3%) samples. All positives were in *D. novemcinctus* armadillos, for prevalence in that species of 14.8% (n = 18/122). We detected positive results mainly in muscle tissue (n = 13/18 [72.2%]) and in 95% ethanol-preserved specimens (n = 13/18 [72.2%]) (Tables 1, 2). *M. lepromatosis* was not detected in the tissues examined. PCR subtyping was successful in 5/18 (27.8%) positive samples; 4 belonged to subtype 3I, as expected for armadillos from Texas, USA (8) (Table 2). The remaining sample was characterized only to type (3 or 4), because we found low amounts of *M. leprae* DNA (Table 2). After RLEP qPCR, 2 samples had a Ct<26 (i.e., 109 and 209) and were suitable for whole-genome sequencing. The genomes of *M. leprae* National Center for Biotechnology Information BioSample no. SAMN31421191 (<https://www.ncbi.nlm.nih.gov/biosample>) had coverage of 18.2× and of BioSample SAMN31421192, 4.9× (Appendix 1). Phylogenetic analysis showed that both *M. leprae* strains belonged to genotype 3I-2 (8,9). The 2 *M. leprae* genomes clustered specifically with other isolates previously identified in armadillos (i.e., I-30) and humans (i.e., NHDP-55 and NHDP-63) from the United States (Figure 2). Isolate 109 harbored 3 specific single-nucleotide polymorphisms, including 1 missense mutation in *argD* (i.e., C1691069T; Arg61Cys), encoding a probable acetylornithine aminotransferase. Sequence data are available from the National Center for Biotechnology Information Sequence Read Archive under accession no. PRJNA893376.

Conclusions

We identified *M. leprae* in *D. novemcinctus* armadillos only; prevalence was 14.8%. Positive samples were mainly detected from muscle and from ethanol-preserved specimens (Table 1). Infected armadillos were found in the United States, Paraguay, and Bolivia. *M. leprae* has not been reported in other wildlife in Paraguay or Bolivia. In our study, tissues from Paraguay were collected in 1996 and from Bolivia in 1993 (Table 2). Hansen disease is prevalent in humans in both countries (10); presence of infected armadillos should prompt research to explore their role as a potential zoonotic source of leprosy (2). In Bolivia, a previous survey of *D. novemcinctus* and *T. matacus* armadillos conducted during 1999–2001 found 0 positive animals (2). We found 7 *M. leprae*-negative armadillo tissues in the United States: 1 from Florida in 1974 and

6 from Texas collected during 1982–1990 (Appendix 2). No evidence for *M. leprae* was reported in Florida before 2009 (8). In Texas, although immunologic detection studies suggested the presence of *M. leprae* in armadillos before the 2000s, evidence was restricted to 1 area (2). Thus, our molecular identification of *M. leprae* in Texas armadillos from 1996, 1999, and 2000 are novel records (Table 2; Figure 1).

Table 1. Characteristics of armadillo tissues from US museum collections examined for *Mycobacterium leprae* and *M. lepromatosis**

Category	No. (%) animals	No. (%) positive for <i>M. leprae</i>
Species		
<i>Dasypus novemcinctus</i>	122 (76.7)	18 (100)
<i>Tolypeutes matacus</i>	20 (12.6)	0
<i>Cabassous unicinctus</i>	5 (3.1)	0
<i>Chaetophractus vellerosus</i>	3 (1.9)	0
<i>Zaedyus pichiy</i>	3 (1.9)	0
<i>Chaetophractus villosus</i>	2 (1.3)	0
<i>Cabassous tatouay</i>	1 (0.6)	0
<i>Chaetophractus</i> sp.	1 (0.6)	0
<i>Euphractus sexcinctus</i>	1 (0.6)	0
<i>Priodontes maximus</i>	1 (0.6)	0
Total	159 (100)	18 (100)
Sex		
M	72 (45.3)	4 (22.2)
F	71 (44.7)	12 (66.7)
Unknown†	16 (10.1)	0
Total	159 (100)	18 (100)
Tissues tested		
Liver	66 (41.5)	2 (11.1)
Muscle	37 (23.3)	13 (72.2)
Spleen	31 (19.5)	3 (16.7)
Unknown	16 (10.1)	0
Lysate	4 (2.5)	0
Heart and kidney	2 (1.3)	0
Kidney	2 (1.3)	0
Heart	1 (0.6)	0
Total	159 (100)	18 (100)
Preservation method		
Frozen	77 (48.4)	4 (22.2)
Ethanol 95%	55 (34.6)	13 (72.2)
Ethanol 70%	17 (10.7)	0
DMSO	9 (5.7)	1 (5.6)
Ethanol 90%	1 (0.6)	0
Total	159 (100)	18 (100)
DNA concentration, ng/μL		
Mean	19	15.63
SD	27.3	12.2
Range	0.0041–218	0.0041–43
Country of origin		
United States	109 (68.6)	16 (88.9)
Paraguay	24 (15.1)	1 (5.6)
Argentina	10 (6.3)	0
Bolivia	7(4.4)	1 (5.6)
Peru	3 (1.9)	0
Brazil	2 (1.3)	0
Unknown	2 (1.3)	0
Costa Rica	1 (0.6)	0
Panama	1 (0.6)	0
Total	159 (100)	18 (100)

*All samples tested negative for *M. lepromatosis*. DMSO, dimethyl sulfoxide.

†Unknown indicates no data were available.

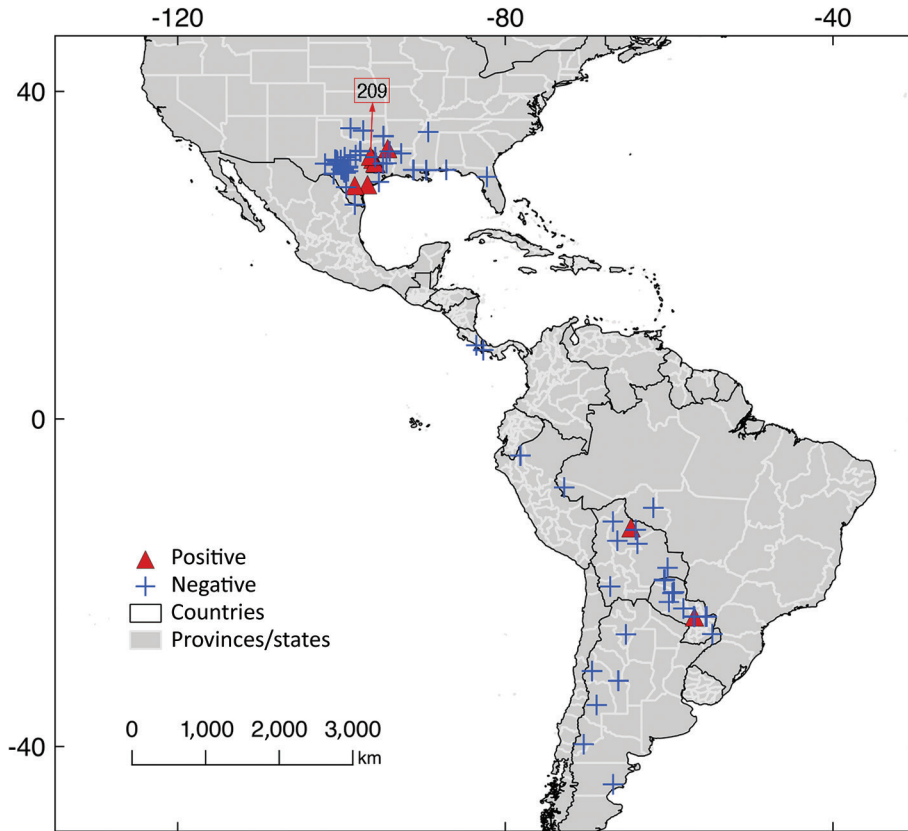

Figure 1. Geographic origin of samples analyzed in study of *Mycobacterium leprae* in armadillo tissue samples from US museums (n = 8 countries). We obtained coordinates from the tissue metadata or georeferenced them manually by using Google Earth (<https://earth.google.com>). Of the 2 samples suitable for whole-genome sequencing, 1, USA-am-109, lacked spatial detail from which to obtain coordinates and is not included on the map, along with 4 additional samples. The other sample that was sequenced, USA-am-209, is indicated with an arrow and the number in a red square.

M. lepromatosis has been reported in multiple countries of the Americas, including the United States, Mexico, and Colombia, but as of 2022, only in humans (11,12). Although this species has been detected in *Sciurus vulgaris* squirrels in the British Isles, broader surveillance in rodents across Europe and

Mexico identified 0 positive samples (13). From our dataset we obtained only negative results. *M. lepromatosis* is seldom screened as a Hansen disease-causing pathogen because of lack of awareness, which has impeded understanding of its incidence. Thus, in countries endemic for Hansen disease, *M. lepromatosis*

Table 2. Characteristics of armadillo tissue samples from US museums identified as positive by standard PCR for *Mycobacterium leprae**

Voucher/tissue no.	Sample ID	Tissue type	Preservation (%)	DNA con.	Country	State	Sex	Year	Type	Subtype	Ct
YPM 16952	63	Muscle	Ethanol (95)	20	USA	Texas	F	2014	ND	ND	ND
YPM 15982	66	Muscle	Ethanol (95)	13	USA	Texas	F	2015	ND	ND	ND
YPM 15294	80	Muscle	Ethanol (95)	2.89	USA	Texas	F	2013	3	3I	34.41
YPM 16954	95	Muscle	Ethanol (95)	11	USA	Texas	M	2014	ND	ND	ND
YPM 15295	97	Muscle	Ethanol (95)	14	USA	Texas	F	2013	ND	ND	ND
YPM 15292	99	Muscle	Ethanol (95)	5.7	USA	Texas	F	2013	ND	ND	ND
YPM 15296	103	Muscle	Ethanol (95)	8.9	USA	Texas	F	2013	ND	ND	ND
YPM 15293	105	Muscle	Ethanol (95)	4.76	USA	Texas	M	2013	ND	ND	ND
YPM 14944	109	Muscle	Ethanol (95)	9.3	USA	Texas	NA	2014	3	3I	23.15
YPM 15315	110	Muscle	Ethanol (95)	0.0041	USA	Texas	F	2013	ND	ND	ND
YPM 15298	111	Muscle	Ethanol (95)	27	USA	Texas	F	2013	ND	ND	ND
YPM 15299	115	Muscle	Ethanol (95)	43	USA	Texas	F	2012	ND	ND	ND
UAM 46589	118	Liver	DMSO	11	Paraguay	Canindeyu	F	1996	ND	ND	ND
MSB 140243	138	Liver	Ethanol (95)	37	Bolivia	Beni	NA	1993	ND	ND	ND
TTU 75235	158	Spleen	Frozen	19	USA	Texas	F	1996	3 or 4	ND	35.12
TTU 82457	194	Muscle	Frozen	3.82	USA	Texas	M	2000	3	3I	31.58
TTU 75360	209	Spleen	Frozen	20	USA	Texas	F	1996	3	3I	25.83
TTU 80673	212	Spleen	Frozen	31	USA	Texas	M	1999	ND	ND	ND

*We identified a total of 18 *M. leprae*-positive samples. Bold text indicates samples suitable for whole-genome sequencing (n = 2). Samples negative for subtyping were determined unsuitable for whole-genome sequencing. Ct determined by quantitative PCR. Ct, cycle threshold; DNA con., concentration of total DNA per sample; NA, no data available; ND, not determined

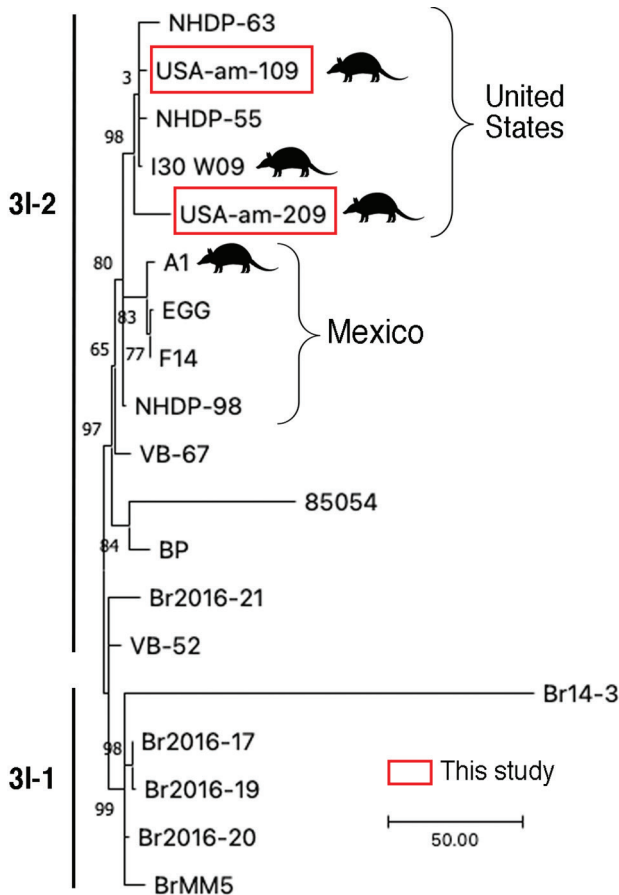

Figure 2. Comparative genomics of the *Mycobacterium leprae* sequenced this study from armadillo tissues from US museums and those from humans and armadillos from the United States and Mexico. Samples subjected to whole-genome sequencing, USA-am-109 and USA-am-209, clustered among genomes from humans and armadillos from the United States (branch 3I). The tree represents a zoom into the *M. leprae* genotypes 3I-1 and 3I-2 from a maximum-parsimony tree of 302 *M. leprae* genomes rooted with *M. lepromatosis* as outgroup. The tree was built in MEGA version 11 software (<https://www.megasoftware.net>). Support values were obtained by bootstrapping 500 replicates. Scale bar indicates number of nucleotide substitutions.

should be also screened systematically in humans and potential animal reservoirs.

We were able to identify *M. leprae* subtypes in 4 armadillos (Table 2) and to sequence 2 entire genomes. Those 2 strains clustered with armadillo and human isolates from the United States, all belonging to subtype 3I-2, on branch 3 of the genetic tree (Figure 2). Of interest, our isolates differed by several nonsynonymous sites from those isolated previously. Our findings corroborate that several strains of *M. leprae* are circulating in armadillo populations in the southern United States (8,9,14). As predicted (15), our data also confirm that the strains circulating in

armadillos today are close to those infecting animals ≥ 30 years ago, highlighting the promise of using preserved animal tissues to study epizootic dynamics of leprosy and other diseases.

Information on pathogen biodiversity in wildlife is much needed. We suggest that specimens in natural museums can play a role in infectious disease monitoring; our study relied on the global museum initiative and the large digital repositories of relevant specimen data in the United States. Protocols for using museum repositories for infectious disease research are still in development (4); parameters to optimal pathogen identification should be explored for *M. leprae* and other pathogens. We recognize that no single best way to study the diversity of pathogens exists; any approach should consider the specific nuances of each zoonotic system.

The reagent genomic DNA from *Mycobacterium leprae*, strain Thai-53, NR-19352 was obtained through BEI Resources, US National Institute of Allergy and Infectious Diseases, National Institutes of Health. Genomic DNA for *Mycobacterium lepromatosis* was provided by Ramanuj Lahiri (National Hansen’s Disease Program, Baton Rouge, Louisiana, USA).

C.A. and M.J. are supported by the Fondation Raoul Follereau, the Heiser Program of the New York Community Trust for Research in Leprosy (grant no. P21-000127), the European Union’s Horizon 2020 Research and Innovation Program (C.A. by Marie Skłodowska-Curie grant no. 845479).

About the Author

Dr. Romero-Alvarez is an MD and PhD candidate at the Biodiversity Institute and the Department of Ecology & Evolutionary Biology at the University of Kansas and is affiliated with the Universidad de las Américas, Quito, Ecuador. His research is focused on the eco-epidemiology and geographic distribution of infectious diseases.

References

- Singh P, Benjak A, Schuenemann VJ, Herbig A, Avanzi C, Busso P, et al. Insight into the evolution and origin of leprosy bacilli from the genome sequence of *Mycobacterium lepromatosis*. *Proc Natl Acad Sci U S A*. 2015;112:4459–64. <https://doi.org/10.1073/pnas.1421504112>
- Ploemacher T, Faber WR, Menke H, Rutten V, Pieters T. Reservoirs and transmission routes of leprosy; a systematic review. *PLoS Negl Trop Dis*. 2020;14:e0008276. <https://doi.org/10.1371/journal.pntd.0008276>
- Avanzi C, del Pozo J, Benjak A, Stevenson K, Simpson VR, Busso P, et al. Red squirrels in the British Isles are infected with leprosy bacilli. *Science*. 2016;354:744–7.
- Colella JP, Bates J, Burneo SF, Camacho MA, Carrion Bonilla C, Constable I, et al. Leveraging natural history biorepositories as a global, decentralized,

- pathogen surveillance network. *PLoS Pathog.* 2021; 17:e1009583. <https://doi.org/10.1371/journal.ppat.1009583>
5. Sharma R, Singh P, McCoy RC, Lenz SM, Donovan K, Ochoa MT, et al. Isolation of *Mycobacterium lepromatosis* and development of molecular diagnostic assays to distinguish *Mycobacterium leprae* and *M. lepromatosis*. *Clin Infect Dis.* 2020;71:e262–9. <https://doi.org/10.1093/cid/ciz1121>
 6. Tió-Coma M, Wijnands T, Pierneef L, Schilling AK, Alam K, Roy JC, et al. Detection of *Mycobacterium leprae* DNA in soil: multiple needles in the haystack. *Sci Rep.* 2019;9:3165. <https://doi.org/10.1038/s41598-019-39746-6>
 7. Monot M, Honoré N, Garnier T, Zidane N, Sherafi D, Paniz-Mondolfi A, et al. Comparative genomic and phylogeographic analysis of *Mycobacterium leprae*. *Nat Genet.* 2009;41:1282–9. <https://doi.org/10.1038/ng.477>
 8. Sharma R, Singh P, Loughry WJ, Lockhart JM, Inman WB, Duthie MS, et al. Zoonotic leprosy in the southeastern United States. *Emerg Infect Dis.* 2015;21:2127–34. <https://doi.org/10.3201/eid2112.150501>
 9. Vera-Cabrera L, Ramos-Cavazos CJ, Youssef NA, Pearce CM, Molina-Torres CA, Avalos-Ramirez R, et al. *Mycobacterium leprae* infection in a wild nine-banded armadillo, Nuevo León, Mexico. *Emerg Infect Dis.* 2022;28:747–9. <https://doi.org/10.3201/eid2803.211295>
 10. Schaub R, Avanzi C, Singh P, Paniz-Mondolfi A, Cardona-Castro N, Legua P, et al. Leprosy transmission in Amazonian countries: current status and future trends. *Curr Trop Med Rep.* 2020;7:79–91. <https://doi.org/10.1007/s40475-020-00206-1>
 11. Cardona-Castro N, Escobar-Builes MV, Serrano-Coll H, Adams LB, Lahiri R. *Mycobacterium lepromatosis* as cause of leprosy, Colombia. *Emerg Infect Dis.* 2022;28:1067–8. <https://doi.org/10.3201/eid2805.212015>
 12. Deps P, Collin SM. *Mycobacterium lepromatosis* as a second agent of Hansen’s disease. *Front Microbiol.* 2021;12:698588. <https://doi.org/10.3389/fmicb.2021.698588>
 13. Schilling AK, Avanzi C, Ulrich RG, Busso P, Pisanu B, Ferrari N, et al. British red squirrels remain the only known wild rodent host for leprosy bacilli. *Front Vet Sci.* 2019;6:8. <https://doi.org/10.3389/fvets.2019.00008>
 14. Truman RW, Andrews PK, Robbins NY, Adams LB, Krahenbuhl JL, Gillis TP. Enumeration of *Mycobacterium leprae* using real-time PCR. *PLoS Negl Trop Dis.* 2008;2:e328. <https://doi.org/10.1371/journal.pntd.0000328>
 15. Schuenemann VJ, Singh P, Mendum TA, Krause-Kyora B, Jäger G, Bos KI, et al. Genome-wide comparison of medieval and modern *Mycobacterium leprae*. *Science.* 2013;341:179–83. <https://doi.org/10.1126/science.1238286>

Address for correspondence: Daniel Romero-Alvarez, Biodiversity Institute and Department of Ecology & Evolutionary Biology, University of Kansas, 1345 Jayhawk Blvd, Lawrence, KS 66044, USA; email: daromero88@gmail.com

etymologia revisited

Petri Dish

[pe'tre 'dish]

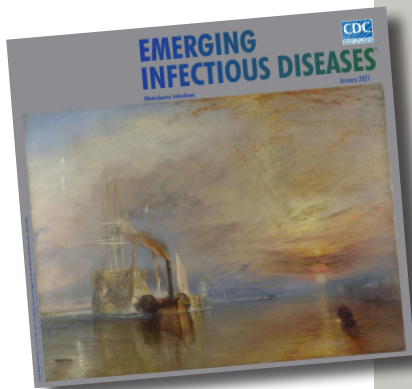

Originally published
in January 2021

The Petri dish is named after the German inventor and bacteriologist Julius Richard Petri (1852–1921). In 1887, as an assistant to fellow German physician and pioneering microbiologist Robert Koch (1843–1910), Petri published a paper titled “A minor modification of the plating technique of Koch.” This seemingly modest improvement (a slightly larger glass lid), Petri explained, reduced contamination from airborne germs in comparison with Koch’s bell jar.

Sources:

1. Central Sheet for Bacteriology and Parasite Science [in German]. Biodiversity Heritage Library. Volume 1, 1887 [cited 2020 Aug 25]. <https://www.biodiversitylibrary.org/item/210666#page/313/mode/1up>
2. Petri JR. A minor modification of the plating technique of Koch [in German]. *Cent für Bacteriol und Parasitenkd.* 1887;1:279–80.
3. Shama G. The “Petri” dish: a case of simultaneous invention in bacteriology. *Endeavour.* 2019;43:11–6. DOI:External
4. The big story: the Petri dish. The Biomedical Scientist. Institute of Biomedical Science [cited 2020 Aug 25]. <https://thebiomedicalscientist.net/science/big-story-petri-dish>

https://wwwnc.cdc.gov/eid/article/27/1/et-2701_article

Mycobacterium leprae in Armadillo Tissues from Museum Collections, United States

Appendix 1

Methods

DNA Extraction

Tissues were processed using an extraction method based on magnetic beads (1,2). Briefly, the 1 mm³ tissue sample loaned from 10 U.S. museums (Appendix 1 Table 1) was suspended in a 1.5 mL Eppendorf tube with 290 µL of tissue lysis buffer and 10 µL of proteinase K (20mg/mL), and left at 55°C overnight. After vortexing the samples, the solution was mixed with 300 µL of in-house developed magnetic beads (2) and left to rest for 5 minutes in a magnetic tube holder. Each tube was then washed with cold 70% ethanol, dried in a thermal block at 37°C, and resuspended with 200 µL of 1x TE buffer. The cleared solution was extracted and deposited in two different tubes per sample. DNA concentration was measured for each sample using a Quantus™ Fluorometer with the QuantiFluor® ONE dsDNA System (Promega, Madison, WI, U.S.), according to manufacturer instructions.

Molecular Identification

We applied primers specific for detection of *M. leprae* and *M. lepromatosis* as described previously (Appendix 1 Table 2) (3–7). Primers for detection of *M. leprae* target a segment of 129 base pairs (bp) from the *M. leprae*-specific repetitive element (RLEP). Sensitivity of these primers is high because this region is repeated at least 36 times across the genome (6,7). For the standard PCR protocol, a final concentration of 25 µL with 3 µL of sample DNA, 2 µL of forward and reverse primers, respectively, at 5 µM initial concentration with 12.5 µL GoTaq® Green Master Mix polymerase (Promega, Madison, WI, USA) at 2x initial concentration, plus molecular-grade water was used.

PCR conditions included denaturation at 95°C for three minutes and 40 cycles of denaturation, annealing, and extension for 30 seconds at 95°C, 40 seconds at 60°C, and 30 seconds at 72°C, respectively. Final extension was at 72°C for 3 minutes. All experiments included a purified sample of *M. leprae* strain Thai53 as a positive control (BEI resource) and molecular-grade water as negative control (6,7).

The presence of *M. lepromatosis* was screened in all samples using the primers LPM244 suggested by Singh et al. targeting a 244 bp of the *hemN* gene, absent in *M. leprae* (3). DNA samples were examined with the same formula and PCR conditions as described above for a final volume of 25 µL. Samples without signs of amplification were reprocessed using primers published half the way of the study that target a multicopy *M. lepromatosis*-specific repetitive element (RLPM (4), amplifying a 100 bp segment (Appendix 1 Table 2). PCR conditions were the same as above except for the annealing temperature: 59°C for LPM244 and 65°C for RLPM primers (3,4,9). We processed a total of 89/159 (55.97%) samples with RLPM primers. Although the optimal approach would have been to test all the samples with these primer set, they were unavailable at the start of the experiment and we no longer have molecular material to screen the remaining samples. All examinations for *M. lepromatosis* yielded negative results. Dr. Ramanuj Lahiri from the National Hansen's Disease Program, Louisiana, U.S., kindly provided a positive control for *M. lepromatosis*; molecular-grade water was used as negative control.

Amplified PCR products were inspected in a 2% agarose gel stained with GelRed® Nucleic Acid Stain (Biotium, Fremont, CA, U.S.) and a 50 bp molecular ladder (Fisher Scientific, Hanover Park, IL, U.S.) using an ultraviolet light trans illuminator (Appendix 1 Figures 1–3). We processed all tissues twice and considered positive any of those with readable bands on the expected fragment sizes on the electrophoresis gel. Amplicons were sequenced by Genewiz and Functional Biosciences. High quality sequences were either aligned or directly compared with published *M. leprae* and *M. lepromatosis* sequences via the basic local alignment search tool (BLAST) using default parameters from Geneious Prime® 2022.0.1.

PCR Subtypification

Subtypification via PCR-based sequencing was performed for all positive samples as follows. We first used a set of primers to differentiate *M. leprae* types between either 1–2 or 3–4 (Appendix 1 Table 3) (10). Then, we used a previously described variant to identify subtype 3I, considering that this is the genotype expected to be circulating in North America (9,11). PCR conditions were implemented as mentioned above, with annealing temperatures calibrated for each primer (Appendix 1 Table 3). Amplicons were sequenced as described above.

Quantitative PCR and Whole-Genome Sequencing

Quantitative real-time PCR (qPCR) was performed on all samples for which genotyping was successful to obtain a proxy of *M. leprae* DNA quantity as an assessment for subsequent genome sequencing steps (8). Briefly, the repetitive element RLEP was quantified using TaqMan® PCR amplification as described previously, with minor modifications (12). A total of 3 µL of each purified DNA sample, or positive (i.e., DNA from Thai-53, NR-19352) or the control (i.e., nuclease-free water), was added to a total PCR reaction volume of 20 µL, containing 10 µL of SsoAdvanced Universal Probes Supermix (Biorad, CA, U.S.), 900 nM of each forward (RLEPq-F) and reverse (RLEPq-R) primer, and 250 nM of the hydrolysis probe (RLEPq-P) (Appendix 1 Table 2). Reaction mixtures were prepared in duplicate, and amplification started with an initial denaturation step of 10 minutes at 95°C and 1 minute at 60°C, using the CFX96 real-time PCR system (BioRad, CA, USA). Data analysis was performed with the CFX Maestro Software (BioRad, CA, USA), and the mean cycle threshold (Ct) was calculated for each sample.

All samples with Ct<26 were prepared for whole genome sequencing (WGS). Briefly, around 100 ng of extracted DNA was fragmented to 300 bp using a Covaris M220 focused ultrasonicator and the MICROtube-130, as recommended by the manufacturer (Covaris, MA, U.S.), followed by a 1.8x AMPure bead clean-up. DNA libraries were prepared using the Kapa HyperPrep Kits, the KAPA universal adaptor and the KAPA UDI primer mix for indexing, and the target enriched capture using the KAPA HyperExplore protocol (kit KAPA HyperExplore Probe protocol, hybridization for 24 hours; Roche, Switzerland). The quality of the DNA library fragment was assessed using

the Screen Tape D1000 on an Agilent TapeStation 4100 instrument (Agilent, CA, U.S.), and the library was quantified via Qubit (ThermoFisher, MA, U.S.). The libraries were multiplexed and sequenced using single-end reads on Illumina NextSeq 500 instrument. Raw reads were processed as described elsewhere (13). A maximum parsimony (MP) tree was constructed in MEGA version 11 (14), with the two new genomes from this study and the genomes from Vera-Cabrera et al. (9), using 500 bootstrap replicates and *M. lepromatosis* as an outgroup.

Supplementary References

1. Rohland N, Reich D. Cost-effective, high-throughput DNA sequencing libraries for multiplexed target capture. *Genome Res.* 2012;22:939–46. [PubMed](#)
<https://doi.org/10.1101/gr.128124.111>
2. Oaks J. SPRI Bead DNA Extraction Protocol. 2020 [cited 2022 Oct 17].
<https://github.com/phyletica/lab-protocols/blob/master/extraction-spri.md>
3. Singh P, Benjak A, Schuenemann VJ, Herbig A, Avanzi C, Busso P, et al. Insight into the evolution and origin of leprosy bacilli from the genome sequence of *Mycobacterium lepromatosis*. *Proc Natl Acad Sci U S A.* 2015;112:4459–64. [PubMed](#)
<https://doi.org/10.1073/pnas.1421504112>
4. Sharma R, Singh P, McCoy RC, Lenz SM, Donovan K, Ochoa MT, et al. Isolation of *Mycobacterium lepromatosis* and development of molecular diagnostic assays to distinguish *Mycobacterium leprae* and *M. lepromatosis*. *Clin Infect Dis.* 2020;71:e262–9. [PubMed](#) <https://doi.org/10.1093/cid/ciz1121>
5. Braet S, Vandellannoote K, Meehan CJ, Brum Fontes AN, Hasker E, Rosa PS, et al. The repetitive element RLEP is a highly specific target for detection of *Mycobacterium leprae*. *J Clin Microbiol.* 2018;56:e01924–17. [PubMed](#)
<https://doi.org/10.1128/JCM.01924-17>
6. Donoghue HD, Holton J, Spigelman M. PCR primers that can detect low levels of *Mycobacterium leprae* DNA. *J Med Microbiol.* 2001;50:177–82. [PubMed](#)
<https://doi.org/10.1099/0022-1317-50-2-177>

7. Tió-Coma M, Wijnands T, Pierneef L, Schilling AK, Alam K, Roy JC, et al. Detection of *Mycobacterium leprae* DNA in soil: multiple needles in the haystack. *Sci Rep*. 2019;9:3165. [PubMed https://doi.org/10.1038/s41598-019-39746-6](https://doi.org/10.1038/s41598-019-39746-6)
8. Avanzi C, Lécorché E, Rakotomalala FA, Benjak A, Rapelanoro Rabenja F, Ramarozatovo LS, et al. Population genomics of *Mycobacterium leprae* reveals a new genotype in Madagascar and the Comoros. *Front Microbiol*. 2020;11:711. [PubMed https://doi.org/10.3389/fmicb.2020.00711](https://doi.org/10.3389/fmicb.2020.00711)
9. Vera-Cabrera L, Ramos-Cavazos CJ, Youssef NA, Pearce CM, Molina-Torres CA, Avalos-Ramirez R, et al. *Mycobacterium leprae* infection in a wild nine-banded armadillo, Nuevo León, Mexico. *Emerg Infect Dis*. 2022;28:747–9. [PubMed https://doi.org/10.3201/eid2803.211295](https://doi.org/10.3201/eid2803.211295)
10. Monot M, Honoré N, Garnier T, Zidane N, Sherafi D, Paniz-Mondolfi A, et al. Comparative genomic and phylogeographic analysis of *Mycobacterium leprae*. *Nat Genet*. 2009;41:1282–9. [PubMed https://doi.org/10.1038/ng.477](https://doi.org/10.1038/ng.477)
11. Truman RW, Singh P, Sharma R, Busso P, Rougemont J, Paniz-Mondolfi A, et al. Probable zoonotic leprosy in the southern United States. *N Engl J Med*. 2011;364:1626–33.
12. Truman RW, Andrews PK, Robbins NY, Adams LB, Krahenbuhl JL, Gillis TP. Enumeration of *Mycobacterium leprae* using real-time PCR. *PLoS Negl Trop Dis*. 2008;2:e328. [PubMed https://doi.org/10.1371/journal.pntd.0000328](https://doi.org/10.1371/journal.pntd.0000328)
13. Benjak A, Avanzi C, Singh P, Loiseau C, Girma S, Busso P, et al. Phylogenomics and antimicrobial resistance of the leprosy bacillus *Mycobacterium leprae*. *Nat Commun*. 2018;9:352. [PubMed https://doi.org/10.1038/s41467-017-02576-z](https://doi.org/10.1038/s41467-017-02576-z)
14. Tamura K, Stecher G, Kumar S. MEGA11: Molecular Evolutionary Genetic Analysis version 11. *Mol Biol Evol*. 2021;38:3022–7. [PubMed https://doi.org/10.1093/molbev/msab120](https://doi.org/10.1093/molbev/msab120)

Appendix 1 Table 1. Museums from the United States with available armadillo tissues*

Museum	No. samples	Website
Museum of Texas Tech University. Natural Science Research Laboratory	46	https://www.depts.ttu.edu/nsrl/collections/search-database.php
Peabody Museum of Natural History	33	https://peabody.yale.edu/explore/collections
Angelo State Natural History Collections	27	https://www.angelo.edu/departments/biology/angelo-state-natural-history-collection/
Sam Noble Oklahoma Museum of Natural History	17	https://samnoblemuseum.ou.edu/
Museum of Southwestern Biology	12	https://msb.unm.edu/divisions/mammals/index.html
University of Alaska Museum of the North	9	https://www.uaf.edu/museum/
Louisiana Museum of Natural History	7	https://www.lsu.edu/mns/collections/mammalogy.php
Museum of Vertebral Zoology	5	https://mvz.berkeley.edu/mvzmamm/
Florida Museum of Natural History	2	https://www.floridamuseum.ufl.edu/collections/
Field Museum of Natural History	1	https://www.fieldmuseum.org/science/research
Total	159	

*Museums ordered according to the number of total individual armadillos contributed to this study.

Appendix 1 Table 2. Primers used to identify *Mycobacterium leprae* and *M. lepromatosis**

Species	Primer	Sequence (5'→3')	Annealing temperature, °C	Amplicon size, bp	Source
<i>Mycobacterium leprae</i>	LP1 (F)	TGCATGTCATGGCC TTGAGG	60	129	(6,7)
	LP2 (R)	CACCGATACCAGCGGCAGAA			
<i>M. lepromatosis</i>	LPM244-F	GTTCTCCACCGACAAACAC	59	244	(3)
	LPM244-R	TTCGTGAGGTACCGGTGAAA			
<i>M. lepromatosis</i>	RLPM-F	TTGGTGATCGGGGTCGGCTGGA	65	100	(4)
	RLPM-R	CCCCACCGGACACCAACCC			
<i>M. leprae</i> (qPCR)	RLEPq-F	GCAGTATCGTGTAGTGAA	60	-	(8)
	RLEPq-R	CGCTAGAAGGTTGCCGTATG	60	-	
	RLEPq-P	FAM-TCGATGATCCGGCCGTCGGCG-QSY	60	-	

*Each primer was calibrated locally to obtain the most adequate annealing temperature using the *Mycobacterium leprae*/*M. lepromatosis* positive control. bp, base pairs.

Appendix 1 Table 3. Primers used for *Mycobacterium leprae* PCR subtyping*

Primer name	Type/Subtype	Gene targeted	Sequence (5'→3')	Nucleic acid change	Annealing temperature, °C	Amplicon size, bp	Source
SNP-73-F	Type 1–2 or 3–4	<i>dnaA</i>	CCCGAAATTTACGAGAACCA	A73G	58	200	(10)
SNP-73-R			AATCCCTCGATGATGGTGAG				
gyrA (3I)-F	Subtype 3I	<i>gyrA</i>	TAAGTCAGCACGGTCAGTCG	C7614T	58	213	Adapted from Truman et al. 2011 (11)
gyrA (3I)-R			TCCCAAATAGCAACCTCAC				

*Each primer was calibrated locally to obtain the most adequate annealing temperature using the *M. leprae* positive control. bp, base pairs.

Appendix 1 Table 4. Whole-genome sequencing results for the samples available in this study (n = 2)

Parameters	Sample 109 (SAMN31421191)	Sample 209 (SAMN31421192)
Total number of reads	9,024,266	10,029,143
Percentage of reads mapping to the reference genome TN (AL450380)	88.16%	88.16%
Coverage (no duplicate)	18.2x	4.9x

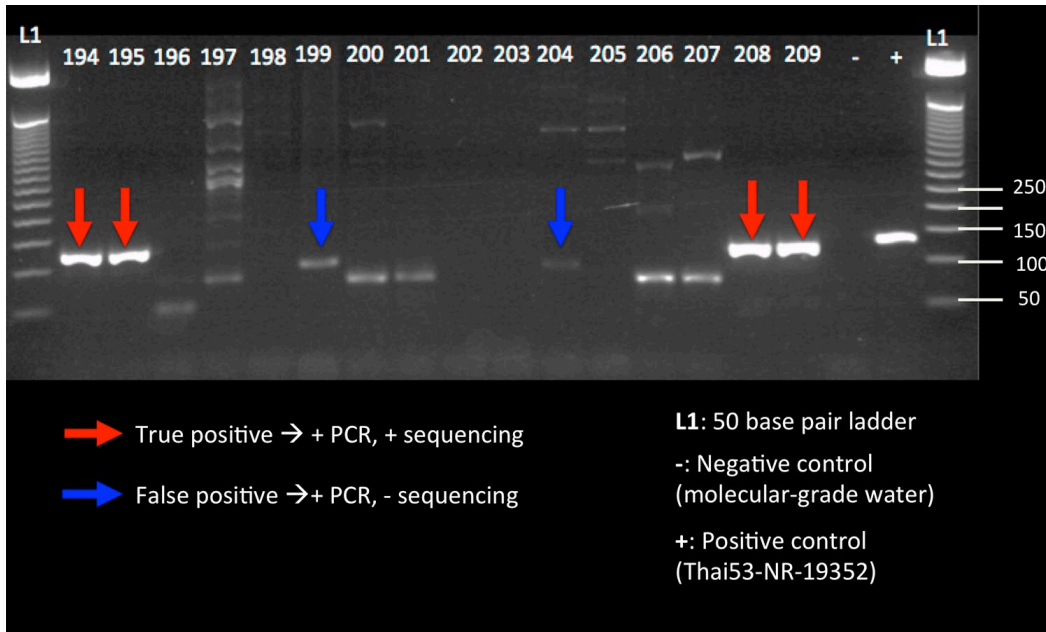

Appendix 1 Figure 1. Example of gel electrophoresis for the identification of *Mycobacterium leprae*. All PCR positives were sequenced to confirm their status as true positives or true negatives. Positive control Thai53-NR-19352.

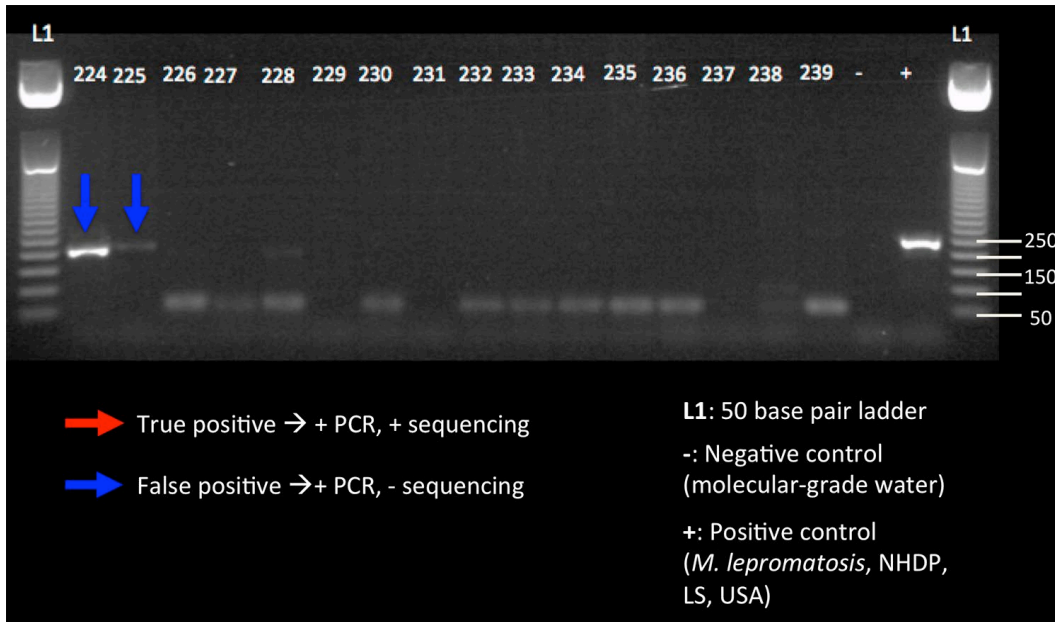

Appendix 1 Figure 2. Example of gel electrophoresis for the identification of *Mycobacterium lepromatosis* with primers LPM244. All PCR positives were sequenced to confirm their status as true positives or true negatives. *Mycobacterium lepromatosis* was donated by Dr. Ramanuj Lahiri from the National Hansen's Disease Program, Louisiana, US. All samples were negative across the examinations.

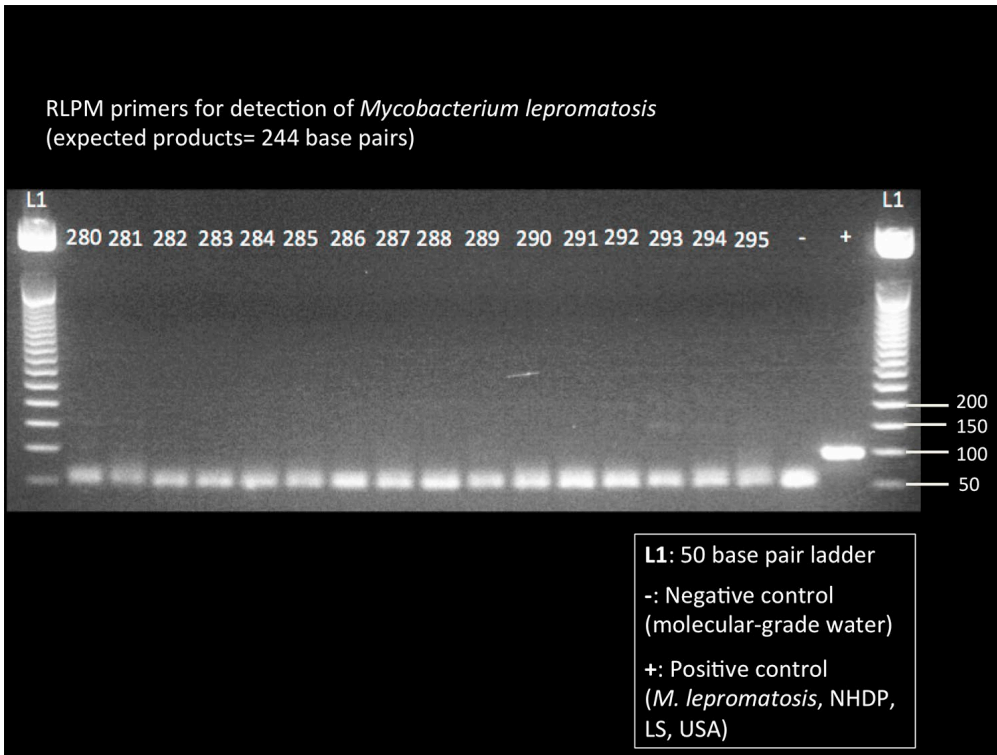

Appendix 1 Figure 3. Example of gel electrophoresis for the identification of *Mycobacterium lepromatosis* with primers RLPM. All PCR positives were sequenced to confirm their status as true positives or true negatives. *Mycobacterium lepromatosis* was donated by Dr. Ramanuj Lahiri from the National Hansen's Disease Program, Louisiana, US. All samples were negative across the examinations.

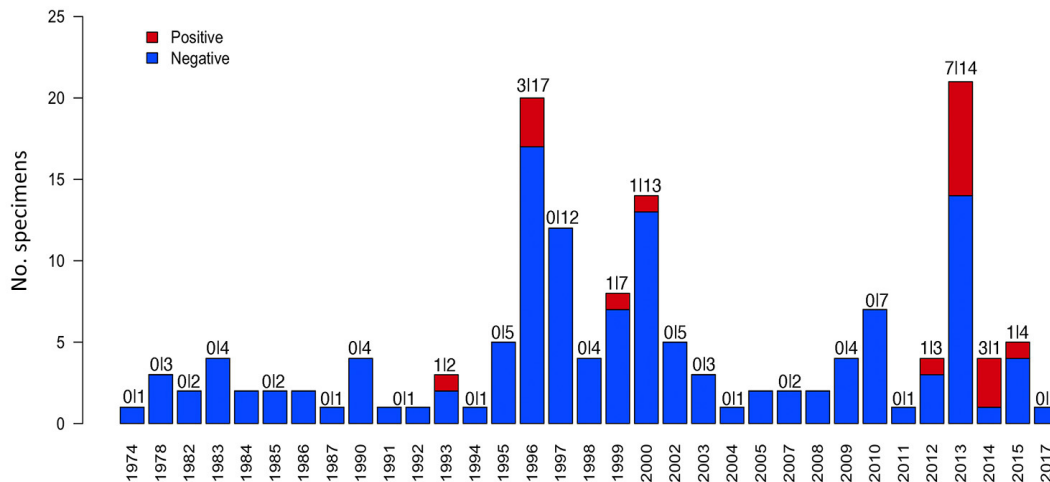

Appendix 1 Figure 4. Armadillo collections from our sample included tissues from 1974 through 2017. Numbers above the bars represent the number of samples that tested negative and positive for *Mycobacterium leprae* for each year.